

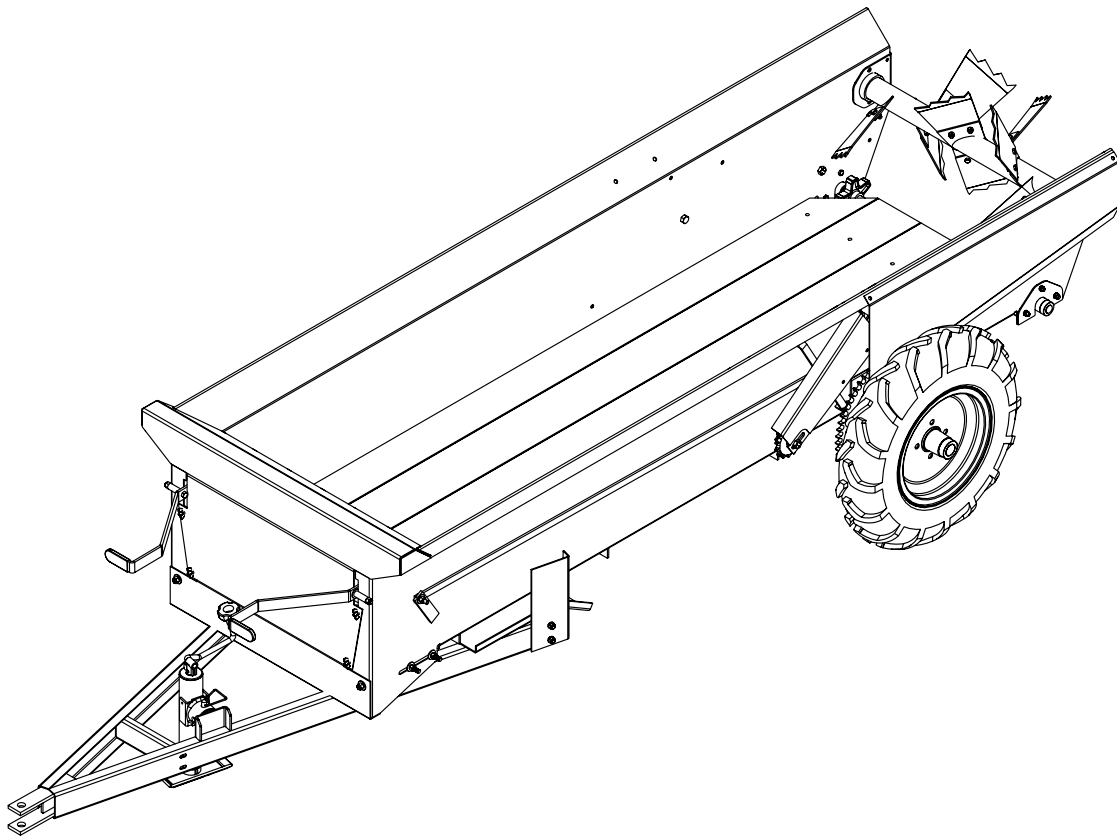

Manure Spreader

Model 35G

Operator's Manual



THIS MANUAL MUST BE READ AND UNDERSTOOD BEFORE ANYONE OPERATES THIS MACHINE!

Manual # 990015
Revised 12/2014

YOU MUST FILL OUT YOUR WARRANTY REGISTRATION TO ACTIVATE YOUR WARRANTY AND TO QUALIFY FOR PARTS AND SERVICE!!

To the Owner;

Thank-You for choosing a quality manure spreader from Pequea Machine, Inc. We strive to give you the best equipment and the best level of service of any company. With a little care and maintenance this machine will do your work for you for many years. In this manual, we make an effort to get you better acquainted with the spreader so you can achieve maximum performance. We design and build all of our equipment with the end user in mind so we welcome any suggestions or ideas for improvement.

Please take a few minutes to fill out the area below. This information will be valuable to you when ordering parts or requesting service from your dealer.

Dealer Name: _____

Dealer Phone Number: _____

Service Manager/Technician: _____

Model# and Description: _____

Serial Number: _____

Date of Purchase: _____

TABLE OF CONTENTS

Introduction	2
Serial Number	2
Specifications	2
Safety	3
Safety Decals	4
Operation	5
Before First Use	5
Vehicle Size	5
Attaching to the Vehicle	6
Loading the Spreader	7
Engaging the Beater and Apron	8
Unloading	8
Maintenance	9
General	9
Drive Chain	9
Apron	10
Lubrication	11
Trouble Shooting	14
Warranty	15
Notes	16

INTRODUCTION

Thank-You for choosing the Pequea Manure Spreader. Your spreader is the result of years of research and development work. This Operator’s Manual will familiarize the operator with the safe and efficient operation of the machine. Included are complete instructions for operation, lubrication, and maintenance procedures. Understanding and following these procedures will result in years of maximum performance from your Pequea spreader.

Read entire manual before operating. Failure to follow the instructions outlined in this manual may result in personal injury and/or damaged equipment, and could void the warranty.

Serial Number

The spreader’s serial number can be found on the outside of the main box of the spreader (Figure 1), usually on the front left corner, under the top flange. Please use this number when requesting service, seeking information, or ordering parts. For the operator’s convenience, space to record the serial number, model number, purchase date, and dealer has been provided inside the front cover of this manual.



Figure 1











All pictures and instructions in this manual assume that the right and left side of the machine are that of someone standing behind the rake facing forward.

Specifications

Model	35G
Capacity	35 Bu. 43 Cu. Ft.
Overall Length	11'6"
Overall Width	44"
Loading Height	30"
Flared Width	34"
Box Width	28"
Box Length	90"
Box Height	16"
Box Construction	Fully welded, 12 Gauge steel
Floor Construction	High density poly vinyl 3/4" T&G
Beater Paddles	8 Replaceable
Beater Diameter	18"
Drive	2 Wheel Ground Drive
Apron Chain	5/16 T-Rod
Spindle	1-5/8"
Wheels/Tires	12 x 6-4 Bolt / 6-12 Traction tires
Weight w/ tires	575 lbs.

SAFETY

Most farm implement accidents can be avoided by the observance of a few simple safety precautions.

-  ***This symbol precedes specific safety instructions throughout this manual. When reading the manual pay close attention to the information that follows this symbol.***
-  FAILURE TO FOLLOW INSTRUCTIONS IN THIS MANUAL COULD RESULT IN PERSONAL INJURY OR DEATH. READ ENTIRE MANUAL BEFORE OPERATING SPREADER.
-  Do not clean, lubricate, or make any adjustments on the spreader while it is in motion.
-  Do not start the spreader until you know everyone is clear of the machine and have made sure no tools are lying on the machine.
-  Keep hands, feet and clothing away from all moving parts. Do not work around the machine while wearing loose clothing that might catch on moving parts.
-  Replace all shields after lubrication or repairs. Shields are provided for your protection and it is your responsibility to make sure they are installed at all times during operation.
-  **Never** allow riders under any circumstances.
-  Always park on level ground or block the wheels to prevent spreader from rolling.
-  When moving the machine on public roads use the proper reflectors, lights, and slow moving vehicle signs required by local government agencies.
-  The combined weight of the spreader and the manure must never be more than the weight of the vehicle (tractor or ATV) you are using to pull the load.

SAFETY

Safety Decals

Decals and reflectors are for the protection of yourself and others. If they are missing, faded, or not readable, get replacements from your dealer immediately.

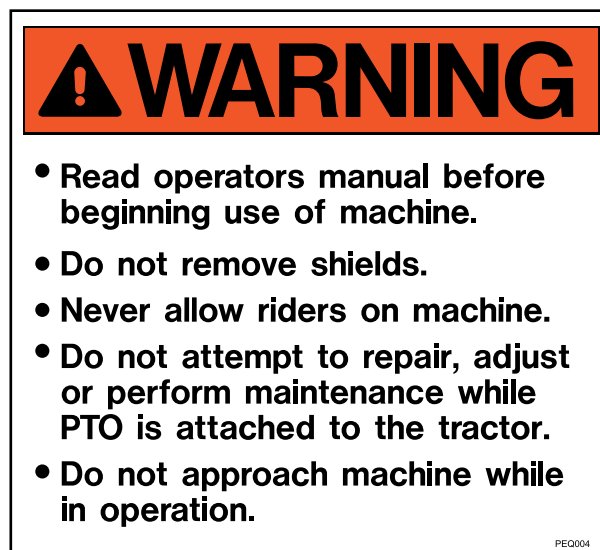

OPERATION

Before First Use

Check for proper assembly and adjustment and make sure all bolts are tight. All bolts were checked at the factory when assembled but need to be checked again as vibrations in shipment may loosen them slightly. Also retighten bolts after several hours of operation.

Torque the wheel lugs to 120 ft. lbs. Recheck the bolts after every other load until the torque does not decrease, then retighten every 100 loads thereafter.

Check the tires and inflate them to the recommended pressure. The tire ratings are printed on the sidewall of the tire.

Adjust the hitch on the tow vehicle and attach the spreader to the vehicle as directed in the following pages.

Lubricate the machine completely. Refer to the Lubrication section of this manual. The initial grease was applied at the factory but proper maintenance is the user's responsibility and must begin before the first use.

Operate the machine slowly for a period of time to run the chains in and confirm that all parts work freely.

Equip the spreader with an SMV (Slow Moving Vehicle) emblem if it will be transported on public roadways.

Do not operate the spreader until the safety precautions in this manual and the decals on the spreader have been read and understood by the operator.

Vehicle Size

A small tractor or ATV may be able to pull the spreader, but it may not be heavy enough to provide adequate traction and braking to control the weight of the loaded spreader on hills. A good rule of thumb is to use a tow vehicle that is heavier than the spreader and load combined.

OPERATION

Attaching to the Vehicle

The spreader is designed to be used with a pin hitch draw bar that is 10"-12" above the ground.

Turn the jack handle to adjust the height of the spreader tongue to match the draw bar height.

Attach to the spreader using a 3/4" diameter pin with a locking clip to prevent the pin from bouncing out.

Remove the weight from the jack and swing it up into the horizontal position to provide maximum ground clearance. (Figures 2 & 3)



Figure 2

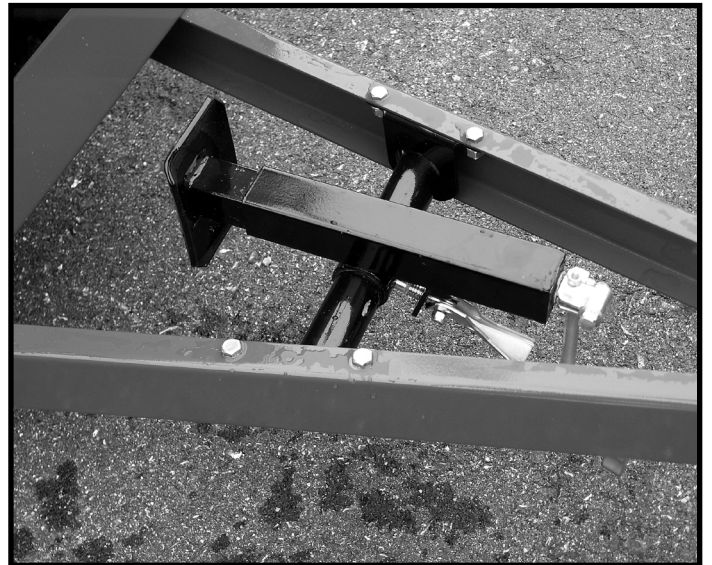

Figure 3

OPERATION

Loading The Spreader

Begin loading the spreader at the front and work toward the rear until full. Loading this way will create a more uniform spread pattern and is especially important when the spreader is loaded with a mechanical loader. For best spreading, level the load 8"-12" higher than the beater, however, with packed manure loaded by a mechanical loader you may need to take smaller loads because of the density of the manure. Do not load the manure directly on top of the beater as this can cause high stress when the beaters are engaged.

If the material has high soil content, wet the box with water or a light oil to prevent premature wear on the spreader sides and chains.

In freezing weather, coating the inside of the box with a light oil will make it easier to clean and will prevent manure buildup. Always check the floor chain and paddles to make sure they are not frozen to the bottom of the bed. Operating the spreader when the paddles are frozen to the bed can cause serious damage to the spreader drive mechanism or the rear web drive shaft. Also make sure there are no lumps of manure frozen to the floor.

OPERATION

Engaging the Beater and Apron

Engage the beaters by lowering the control arm until locked in the horizontal position. The beater control lever is on the left side of the spreader (right side if you are facing the front of the spreader). Engage the beaters slowly and insure that the chain has dropped onto the sprocket correctly.

Engage the apron chain by lowering the control arm on the right side of the spreader (left side if you are facing the front of the spreader).

Never operate the spreader with only the apron engaged. If the beaters are not engaged the manure will be forced back against the beater and can cause serious damage to the drive mechanism. The only exception to this is to clean out the spreader when it is nearly empty.

Never engage the beaters or the apron when the spreader is in motion. This will cause premature wear and stress on the drive chain and sprocket or the drive mechanism.

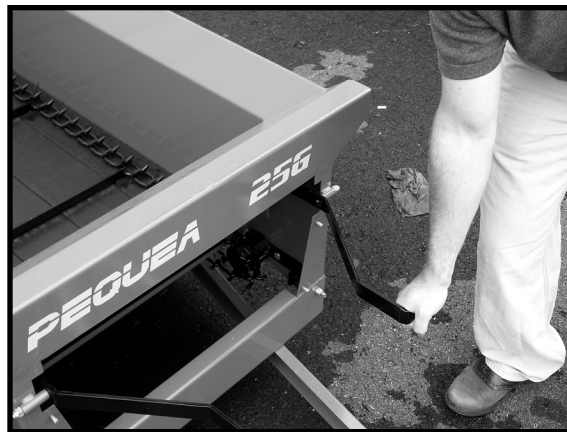

Figure 4

Unloading

Generally speaking, the drier the manure is, the better and more even your spread pattern will be. Wet manure with large “chunks” can also be a nuisance when the spreader is nearly empty. The load itself usually blocks material from being thrown forward but in the case of a significantly reduced pile the rotation of the beater can throw some material forward. There are several things that can be done to prevent this.

- Reduce your ground speed.
- Disengage beater and just allow the rest of the manure to drop out.
- If you haven't finished spreading you can just leave the last of the manure in and refill.

MAINTENANCE

General

Remove manure buildup regularly.

Protect the machine from the weather when it is not in use. Store indoors and out of direct sunlight as much as possible. Being exposed to the weather and direct sunlight will eventually dry rot the tires and fade the paint.

Periodically check all hardware and retighten if necessary. There will be some vibration during operation which can cause fasteners to loosen.

Keep the beater paddles clean. Remove all materials such as twine or wire that would wrap around the beaters and promote buildup. If there is too much buildup it will cause unnecessary stress and vibration on the beaters.

Occasionally power wash the whole spreader and touch up any chips or scratches with paint.

Drive Chain

When the drive chains are properly tensioned they should deflect 1/2" from a straight line midway between the sprockets. The chain tension is maintained by a compression spring at the end of the lifting arm. If the chain deflection is excessive you may need to replace the spring or remove a link from the chain.

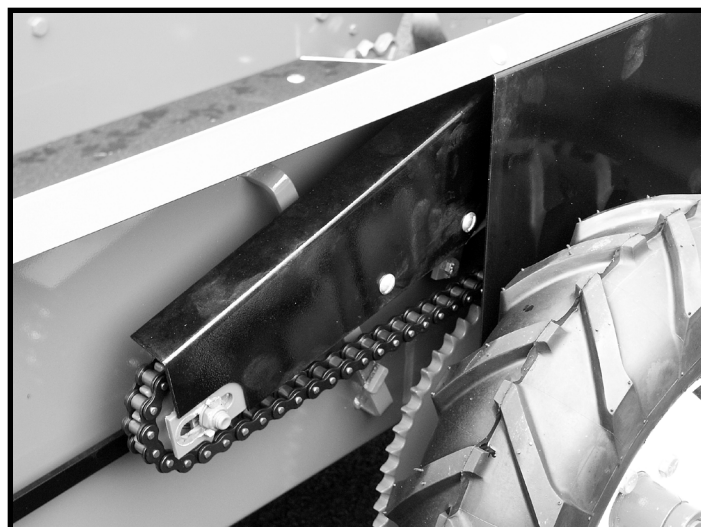

Figure 5

MAINTENANCE

Apron

Periodically inspect the apron for bent or damaged slats. Always straighten or replace any bent or damaged slats immediately.

The apron chain tension should be adjusted periodically as the chain stretches. To check for the proper tension, measure the distance between the apron chain and the axle shaft. This measurement should be between one and three inches. Follow the steps below to make the adjustment;

Loosen the two 1/2" bolts (A) on the side of the spreader.
Turn the adjustment bolt (B) on the front of the spreader to reach the desired tension.
Retighten the 1/2" clamping bolts (A).

If the chain becomes stretched too much you may need to remove a link. The tension must be released before doing this.

Be sure to have equal chain tension on both sides. If one side is tighter than the other it may slip off the sprocket or cause the slats to bend.

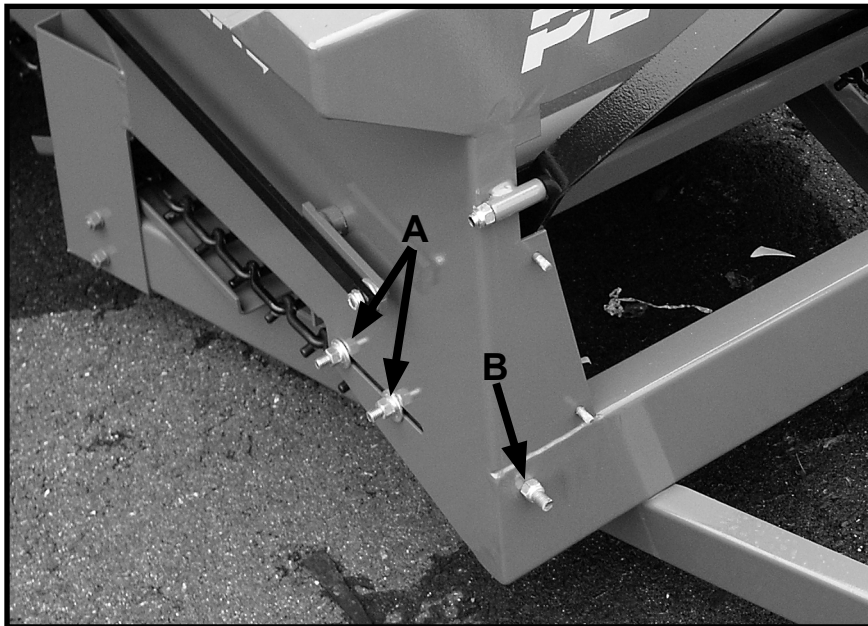

Figure 6

LUBRICATION

The Model 25G is designed to require little maintenance and lubrication. However, it is still important to keep all moving parts well lubricated. Following a regular maintenance and lubrication schedule will enhance the operation and increase the life of the spreader significantly. The following pages show the grease points on the spreader. The operator should establish a systematic routine to ensure complete and quick lubrication of the spreader.

The spreader should be greased every 50 loads or once a month. Wipe the old grease and any dirt or dust off the grease fittings before greasing so it doesn't get forced into the bearing.

There are two grease fittings inside the front cover on the engaging lever pivot. One on each side of the spreader.



Figure 7

There is a grease fitting on each wheel hub.



Figure 8

LUBRICATION

There is one grease fitting on each axle bearing.



Figure 9

There is one grease fitting on each rear web bearing.

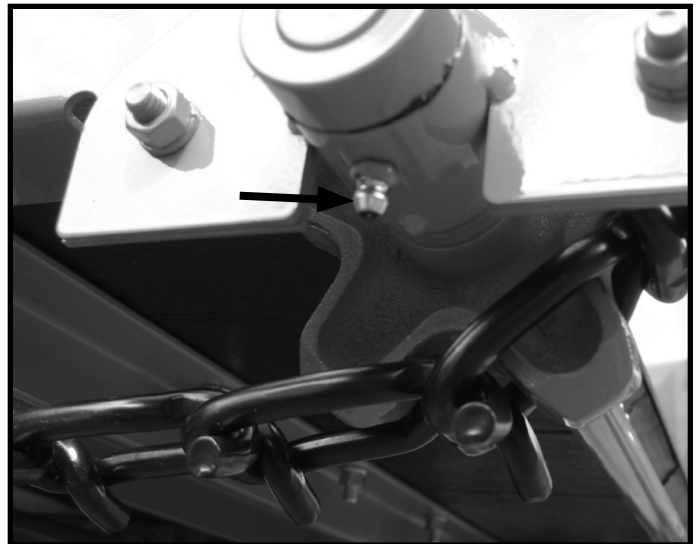

Figure 10

There is one grease fitting on each beater bearing.

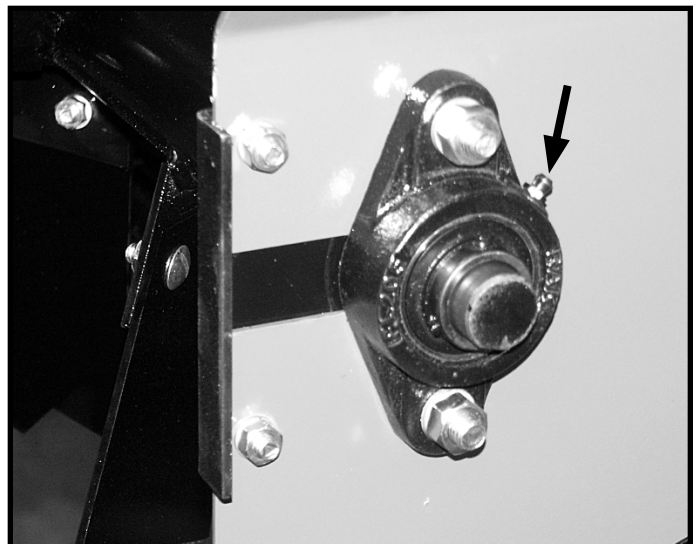

Figure 11

LUBRICATION

Lubricate the apron chain with SAE #30 oil or similar lubricant at least twice yearly. More often if the manure is of high acid nature or if the spreader is stored outside. Regular lubrication of the apron chain will substantially increase its life



Figure 12

Lubricate the beater drive chain with engine oil every 50 loads or once a month.

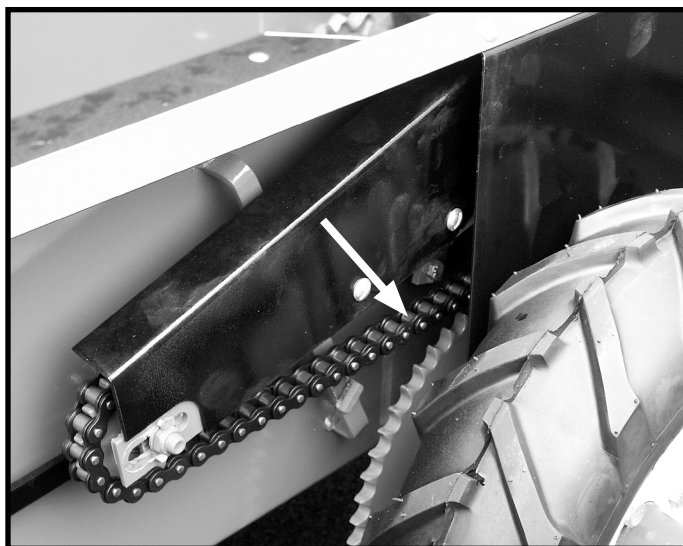

Figure 13

TROUBLE SHOOTING

Problem	Possible Cause	Correction
Apron chain came off sprocket	Freezing conditions, Bent apron slats	Always be sure apron is not frozen before spreading, replace bent slats
	Loose apron chain	Adjust chain
Bending apron slats	Loose apron chain	Adjust chain
Spreader is moving but beaters won't spin.	Drive chain is broken or has jumped off sprockets	Repair chain and realign with sprockets
	Dawg springs weak or broken	Remove hub and check or replace dawg springs
Spreader pulls harder than normal	Material has jammed in the beaters or the drive chain	Remove foreign material and check for any damage
	Lack of lubrication, spreader not greased properly	Lubricate chains and grease all fittings as recommended
Beaters or apron drive will not engage	Check for broken or bent linkage rod	Replace linkage rod

WARRANTY

Pequea Machine's Limited Warranty

Pequea Machine Company warrants to the original Purchaser all Machinery, Equipment, or Trailers manufactured by it, to be free from defects in material and workmanship under normal use and service. Its obligation under this Warranty shall be limited to replacement or repair of any parts thereof, free of charge to the original Purchaser, at its place of business, provided, however, that the part(s) to be replaced or repaired, shall within one (1) year after delivery to the original Purchaser, be demonstrated to be defective; which determination shall be made by the Company. The said components or parts must be returned through the Selling dealer or distributor directly to the Company with all transportation charges prepaid. Notice of defect shall be furnished in writing to the Seller and to the agent through whom the machinery was received, disclosing in full all known defects and failure in operation and use, and reasonable time shall be given to the Seller to remedy any such defects and failures. Failure to make such trial or give such notice shall be deemed an absolute acceptance by the Buyer and satisfaction in full of this Limited Warranty.

This Warranty does not cover, under any circumstances, any parts, components, or materials which, in the opinion of the Seller and Company, have been subjected to neglect, misuse, alteration, accident, or if repaired, with parts other than those manufactured by and obtained from Pequea Machine Company.

This Warranty does not cover components which are already covered by a separate Warranty provided by the supplier of said parts or components.

The Company's obligation under this Warranty is limited to repair or replacement, free of charge to the original Purchaser, of any part which in judgment of the Company is defective. This Warranty does not cover normal wear and tear.

THIS WARRANTY IS MADE EXPRESSLY IN LIEU OF ALL OTHER WARRANTIES, EXPRESSED OR IMPLIED, INCLUDING ANY WARRANTY OF MERCHANTABILITY AND FITNESS FOR USE AND PURPOSE AND OF ALL OTHER OBLIGATIONS OR LIABILITIES ON ITS PART AND ANY IMPLIED WARRANTY. AND IT NEITHER ASSUMES NOR AUTHORIZES ANY OTHER LIABILITY IN CONNECTION WITH A SALE OF THIS MACHINE. THIS WARRANTY SHALL NOT APPLY TO THIS MACHINE OR TO ANY PART THEREOF WHICH HAS BEEN SUBJECT TO ACCIDENT, NEGLIGENCE, ALTERATION, ABUSE, OR MISUSE.

The Company makes no Warranty whatsoever in respect to accessories or parts not supplied by the Company. The term "original Purchaser" as used in this warranty, shall be deemed that person for whom the Machine, Equipment, or Trailer is originally supplied. This Warranty shall apply only within the boundaries of the continental United States.

Under this Warranty, the Company cannot guarantee that existing conditions beyond its control will not affect its ability to obtain materials or manufacture necessary replacement parts.

No one is authorized to alter, modify, or change the terms of this Warranty in any manner.

The Company warrants the Construction of the equipment sold herein and will replace at its expense for a period of (1) year from the date hereof, any parts which prove defective as determined under the terms of this Limited Warranty.



200 Jalyn Drive
P.O. Box 399
New Holland PA 17557

Phone: 717-354-4343
Fax: 717-354-8843
E-mail: pequea@pequeamachine.com
www.pequeamachine.com