



Pequea Turbo Tedder

Model TT4101

Operator's Manual



THIS MANUAL MUST BE READ AND UNDERSTOOD BEFORE ANYONE OPERATES THIS MACHINE!

*Manual# 990046
Revised 07/26/2017*

YOU MUST FILL OUT YOUR WARRANTY REGISTRATION TO ACTIVATE YOUR WARRANTY AND TO QUALIFY FOR PARTS AND SERVICE!!

To the Owner;

Thank-You for choosing a quality product from Pequea Machine, Inc. We strive to give you the best equipment and the best level of service of any company. With a little care and maintenance this machine will do your work for you for many years. In this manual, we make an effort to get you better acquainted with the machine so you can achieve maximum performance. We design and build all of our equipment with the end user in mind so we welcome any suggestions or ideas for improvement. Please note that it is within our rights to make changes or improvements to our equipment without updating the equipment that was manufactured before the change took place.

Please take a few minutes to fill out the area below. This information will be valuable to you when ordering parts or requesting service from your dealer.

Dealer Name: _____

Dealer Phone Number: _____

Service Manager/Technician: _____

Model# and Description: _____

Serial Number: _____

Date of Purchase: _____

TABLE OF CONTENTS

Introduction	2
Intended Use	2
Serial Number	2
Specifications	2
Safety	3
Power Source Safety	3
Safety Decals and Reflectors	4
Hitching	5
Tractor Requirements	6
Tractor Requirements	6
Transporting	8
Field Transport	8
Road Transport	8
Set-up	8
Axle Adjustments	8
Tine Height Adjustment	9
Sequencing Valve	9
Tine Pitch Adjustment	10
Operation	11
Lubrication & Maintenance	12
General Maintenance	12
Gearbox Lubrication	13
Wheel Bearings	13
General Lubrication	13
PTO Lubrication	15
Timing the Rotors	16
Warranty	19

INTRODUCTION

Intended Use

Pequea Tedders are designed for evenly distributing hay and forage crops only. Pequea will not cover under warranty a tedder that has been used outside of these crops.

Serial Number

The tedder's serial number can be found on the side of the tedder tongue. Please use this number when requesting service, seeking information, or ordering parts. For the operator's convenience, space to record the serial number, model number, purchase date, and dealer has been provided inside the front cover of this manual.

Specifications

Specifications	TT4100
Working Width	18' 2"
Transport Width	10' 6"
Gearboxes	Grease/Oil Bath
Rotors	4
Arms Per Rotor	7
Arm Construction	Round Tubular
PTO/HP Recommended	35+
Weight	1350
Spindle Size	1-3/8"
Hub	4-Bolt w/ Tapered Bearings
Wheels	4-Bolt Heavy Duty, Painted
Tires	18.5 x 8
Hydraulic Requirement	1000psi

SAFETY



This symbol precedes specific safety instructions throughout this manual. When reading the manual, pay close attention to the information that follows this symbol.



FAILURE TO FOLLOW INSTRUCTIONS IN THIS MANUAL COULD RESULT IN PERSONAL INJURY OR DEATH. READ ENTIRE MANUAL BEFORE OPERATING THE TEDDER.



Keep hands, feet and clothing away from the machine's power take-off (PTO) shaft and any other moving parts until the machine has been shut down and the power source has been locked out.



Do not adjust, unclog, lubricate, or service the tedder until it has been shut down.



Support the tedder securely while working under it.



Be certain all bystanders and animals are a safe distance away before raising or lowering the rotors.



Never allow anyone to ride on the tractor or the tedder.



When transporting, never exceed a speed of 19 MPH and avoid sudden turns.



Be constantly aware of the ends of the machine to avoid collision with other objects.



When transporting the machine on public roads use the proper reflectors, lights, and slow moving vehicle signs required by local government agencies. Pequea will not be liable for any traffic violations.



Be sure to check all fasteners before and after every use, this is especially important when the tedder is new but is a good practice on any machinery with high vibration levels.



Be careful around hydraulic hoses and fittings. Never go near hydraulic leaks. High pressure leaks can puncture skin and cause serious injury or death!

SAFETY

Safety Decals and Reflectors

Safety decals and reflectors are for the safety of yourself and others, and must be heeded at all times. If any decals are missing, faded, or damaged in any way, please contact your dealer for replacements immediately. Shown below are some of the decals used on your tedder.



WARNING

To help prevent entanglement, stand clear of tines.

Disengage and shut off all engine power before adjusting tine height.



DANGER

Entanglement in rotating driveline can cause serious injury or death.

Keep all shields in place.

Avoid contact with rotating parts.



WARNING

Avoid contact with rotating parts.

Do not touch tines or other rotating parts during service or transport.

Do not touch tines or other rotating parts before dismounting or parking equipment.

Do not touch tines or other rotating parts while engine is running.



CAUTION

To avoid serious injury:

- Read Operator's Manual before operating, servicing or repairing equipment. Follow all safety rules and instructions. (Manuals are available from your selling dealer.)
- Never allow riders.
- Keep bystanders away from equipment during operation.
- Operate from tractor seat only.
- Keep all shields in place and good condition.
- Lower equipment to ground, stop engine, remove key and set brake before dismounting tractor.
- Never allow children or untrained persons to operate equipment.



CAUTION

Operate only with 540 rpm PTO.

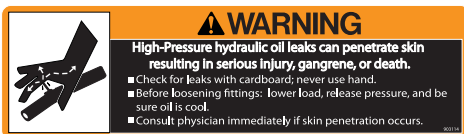
WARNING

High-Pressure hydraulic oil leaks can penetrate skin resulting in serious injury, gangrene, or death.

- Check for leaks with cardboard; never use hand.
- Before loosening fittings: lower load, release pressure, and be sure oil is cool.
- Consult physician immediately if skin penetration occurs.



WARNING

THROWN OBJECTS

Do not operate near people. Debris can be thrown a long distance.



WARNING

Do not exceed this implement's maximum transport speed of 32km/h (20mph).

Exceeding this speed may result in loss of control during transport or braking and serious injury or death.

Transport only with a properly ballasted tractor and a properly attached safety tow chain.

Do not transport with a motor vehicle.

Reduce speed and use additional caution when on inclines, towing under adverse surface conditions, and turning.

SAFETY

Stay Clear of Rotating Drivelines



TS1644-UN-22AUG95

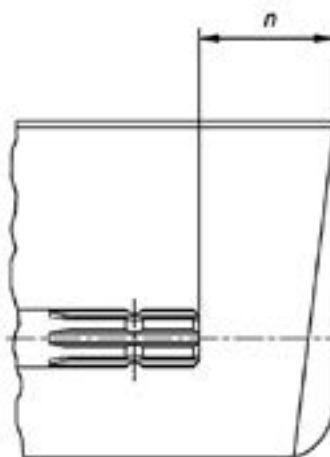

H96219-UN-29APR10

Entanglement in rotating driveline can cause serious injury or death.

Keep tractor master shield and driveline shields in place at all times. Make sure rotating shields turn freely.

Wear close fitting clothing. Stop the engine and be sure that PTO driveline is stopped before making adjustments, connections, or cleaning out PTO driven equipment.

Do not install any adapter device between the tractor and the primary implement PTO drive shaft that will allow a 1000 rpm tractor shaft to power a 540 rpm implement at speeds higher than 540 rpm.

Do not install any adapter device that results in a portion of the rotating implement shaft, tractor shaft, or the adapter to be unguarded. The tractor master shield shall overlap the end of the splined shaft and the added adaptor device as outlined in the table.

PTO Type	Diameter	Splines	$n \pm 5 \text{ mm (0.20 in.)}$
1	35 mm (1.378 in.)	6	85 mm (3.35 in.)
2	35 mm (1.378 in.)	21	85 mm (3.35 in.)
3	45 mm (1.772 in.)	20	100 mm (4.00 in.)

HITCHING

Tractor Requirements

The Pequea Tedder is designed to be used with a tractor having a 540 RPM PTO. The hitch pin hole on the tractor should be 14" (35cm) from the groove in the PTO output shaft. (See illustration below)

NOTE: If the hitch pin hole is located well behind the tractor tires there is the potential of making a sharp enough turn to damage the PTO shaft.

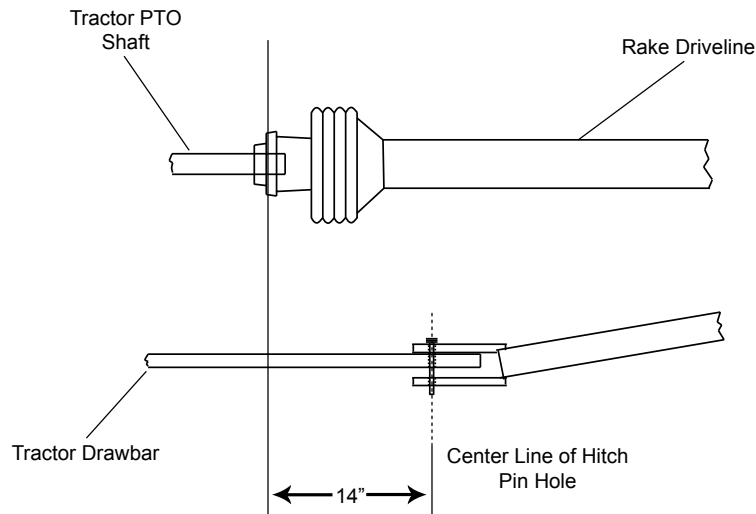

Hitching

Align the hole in the tractor draw bar with the hole in the rake tongue and insert an approved hitch pin. Lock hitch pin with a safety clip to insure that it cannot work its way out.

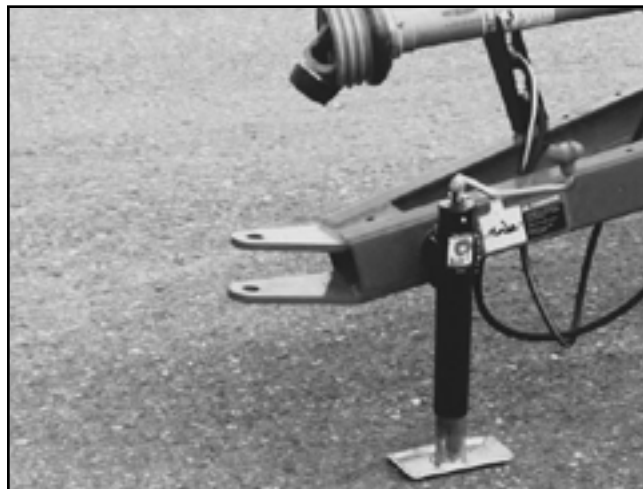

Figure 1

HITCHING

With PTO shaft connected to the tedder, slide shaft safety collar back and slide the tractor side of the PTO shaft onto the tractor drive shaft. Release the shaft safety collar. Insure that the PTO shaft is securely locked onto the tractor drive shaft. Fold the PTO stand down onto the frame to avoid damaging the PTO shaft shielding. (Figure 2)



Figure 2

Connect the tedder hydraulic lines to the tractor implement hydraulic output.

Plug the electrical harness into the tractor to operate the lights (If applicable).

Crank the jack up until the foot is off the ground and remove the locking pin. Pull the jack off of the mount, place in storage position on the main frame, and reinsert locking pin. Figure 3 shows the jack in the storage position.



Figure 3

TRANSPORTING

Field Transport

Always transport the tedder with the wings raised in the transport position to reduce the overall width.

Never allow any riders on the tractor or the tedder.

Avoid tight turns to reduce the possibility of loss of control or PTO shaft damage.

Remain fully aware of the width of the tedder in relation to objects you are passing, either stationary or moving.

Never travel at speeds over 10 MPH (16km/hr.) in the field.

Road Transport

Adhere to all suggestions for transport in the field listed above.

Follow all local regulations for moving agricultural equipment on public roads, especially those related to reflectors, SMV (slow moving vehicle) symbols and safety markers.

Never travel at speeds over 20 MPH (32km/hr.) on the road.

Never travel on the road at night unless your tedder is equipped with lights.

SET-UP

Axle Adjustments

The angle of the axles can be adjusted to raise or lower the whole machine. This will allow you to tilt the tedder forward more and get a more aggressive tending action. The tedders are set at the factory to run in the less aggressive position (shown at right). To adjust to the higher position you will need to pick the tedder up off the ground using a hoist or a lift. With the tedder's weight supported properly with blocks, remove the 1/2" bolt, pull the axle forward to meet the second hole, and reinsert bolt. Repeat the process for all the axles.



Figure 4

Tine Height Adjustments



Never attempt to make any adjustments unless the tedder and tractor have been shut off and have come to a complete stop.

Correct tine clearance cannot be stressed enough as it is essential to minimize crop loss, prevent premature wear of tines, and decrease crop contamination which can result in premature wear of your processing equipment. Turn the tilt cylinder pitch adjustment handle (Figure 4) clockwise to raise the tine height or turn the handle counter clockwise to lower the tine height. Flip the wire lock over the handle to keep the handle from turning during operation. Generally, the tines should be around 1-2 inches from the ground for most crops. However, each situation is different and factors like field conditions, stubble length, and crop moisture can change where the optimum setting should be.

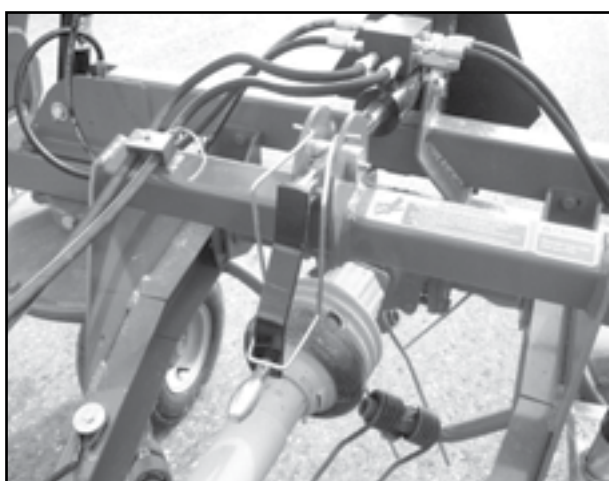

Figure 5

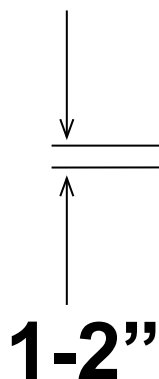

Figure 6

Sequencing Valve

The sequencing valve is shown in the image to the right. It is set from the factory, but will need to be adjusted slightly for a tractor with a higher hydraulic pressure. If you encounter a problem in which the tilt cylinder will not engage, you are operating on a high pressure and will need to adjust the pressure setting on the valve. To do this, you need to remove the end cap from the valve using a 5/16" hex wrench. You will see the adjustment screw inside the valve. Adjust the screw clockwise using a 1/4" hex wrench until you get the desired results. You should not have to tighten more than a full turn except in an extremely high pressure system. Be sure to put the end cap back on before applying any hydraulic pressure.

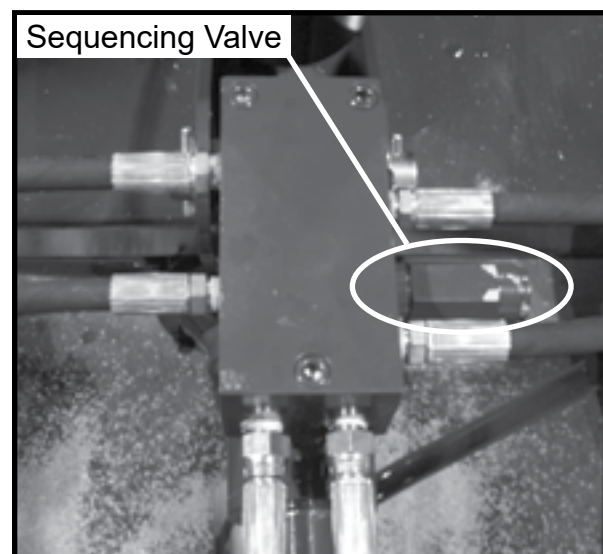

Figure 7

ADJUSTMENTS

Tine Pitch Adjustments



Figure 8



Figure 9

The tine pitch (the angle at which the tine comes off of the time arm) can be adjusted by turning the eccentric spacer washer. The spacer position in Figure 7 will give the tine a less aggressive position as shown in Figure 8.

The spacer position as shown in Figure 9 will give the tine a more aggressive position as shown in Figure 10.

A more aggressive tine position will throw the crop higher.



Figure 10



Figure 11

OPERATION

Having made adjustments (where necessary) described in the previous sections, drive the tractor to where you will begin tedding. With the tractor standing still, lower the tedder to its operating position. Engage the tractor's PTO at a low RPM, (this is especially important on a tractor with an electric clutch) and without getting off the tractor seat, visually determine that the tedder is properly adjusted. If further adjustments are required, disengage the PTO and stop the tractor's engine and adjust where needed.

When ready, increase PTO speed to the desired RPM and engage the tractor's forward gear. The correct ground speed/PTO speed ratio, along with the proper adjustment for height and level, will ultimately determine the quality of the tedding job. 6 MPH (9.6 km/hr.) ground speed and 500 PTO RPMs is a good starting point. However, you may need to change setting and/or speeds for different crop conditions. Adhere to all safety requirements as listed previously for field operation.

Always operate the tedder at the lowest RPM possible while still picking up all the material. Higher speeds result in more leaf loss and lower quality hay, especially if you are tedding alfalfa hay. Higher speeds will also cause more wear on the tedder and will also promote wrapping of hay around any rotating parts.

While operating the rake you must constantly be aware of all your surroundings. The guards are designed for human safety and will not withstand a collision with a stationary object such as a fence post or an electric pole. If such a collision does occur and you cannot stop before the tine arms hit the obstacle, the radial pin clutch on the gearbox input shaft will engage and should protect the gearbox from any serious damage. The slip clutch will not engage fast enough to protect the tine arms.

This tedder has been designed to tolerate a fair amount of abuse due to rough field conditions, However, this is no excuse for careless operation and it is the operator's sole responsibility to avoid conditions such as washouts, ditches, animal dens, and sink holes. These hazards can cause severe damage to the rake. Damages incurred due to carelessness by the operator will not be covered under warranty by the manufacturer.

LUBRICATION & MAINTENANCE

It is extremely important to keep your tedder properly lubricated at all times. Failure to do so will greatly decrease the performance and the life of the machine.

Never lubricate or perform any maintenance, adjustments or repairs with the machine running. The PTO must be disengaged and the tractor's engine must be shut off.

Do not over grease the sealed bearings. Over greasing could rupture the seals exposing the bearing to a lot of dust particles. Roller bearings are sealed and are generally maintenance free. The friction bearing points cannot be over greased.

General Maintenance

Check the tire pressure. Tires should be inflated to 20psi.

Periodically check for loose fasteners. Fasteners are all torqued at the factory but vibrations from normal operation may cause some of the fasteners to loosen, especially when the machine is relatively new.

The wheel hubs should be checked to make sure the bearings are snug and do not allow the wheel to wobble during operation.

Check the guards before each use to make sure they are not bent, damaged or missing. Do not operate the tedder without proper safety guarding.

Check the tines before each use to make sure none are broken, loose or missing. Missing tines will affect the performance of the tedder and will also throw the rotor off balance causing undue stress and vibration.

Check all hydraulic lines for leaks or other damage. Do not use the tedder if any of the lines are damaged.

Make sure all the safety decals are legible.

LUBRICATION & MAINTENANCE

Gearbox Lubrication

The oil in the center gearbox (Figure 11) should be drained and replaced before each season. Drain all the old oil and replace with 64 oz of new SAE 80W90 gear oil.

The rotor gearboxes (Figure 12) have been packed with grease at the factory and should not need to be maintained. However, they should be checked before each season to make sure the gears are still coated with a film of grease. If additional grease is needed, use 2-4 ounces of NLGI #2 gear grease.

Be sure to properly dispose of any used oil or grease! Do not pour directly onto the ground!

OIL FILL PLUG

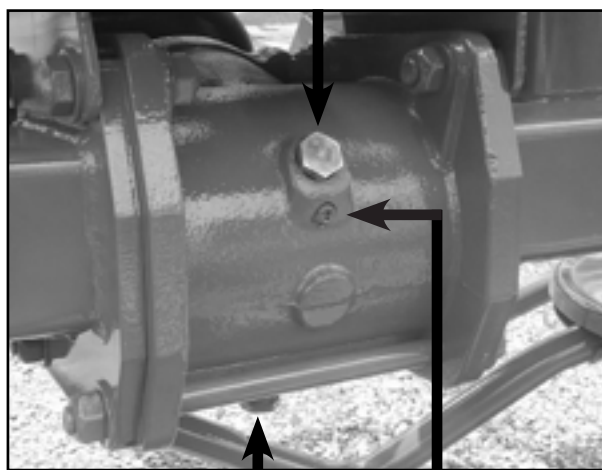

Figure 12

OIL DRAIN PLUG CHECK PLUG



Figure 13

Wheel Bearings

Check wheel bearings for proper lubrication before each season. If the bearing grease is becoming dry or caked the bearings should be cleaned and re-packed with new multi purpose grease.

General Lubrication

All other grease fittings should be lubricated after every 50 hours of operation. Use a quality multi purpose grease for all bearings, joints, and pivot points. In dry, dusty conditions it may be necessary to grease more than every 50 hours. In the following pages we show the location of the grease fittings. Before greasing, use a clean cloth and wipe off both the grease fitting and the tip of the grease gun. This will eliminate any chance of dirt or dust particles getting inside and damaging the bearings or friction surfaces.

LUBRICATION & MAINTENANCE

General Lubrication

The wing pivots are greasable through a fitting on the end of each pivot pin. These are friction pivot points and should always be kept wet with grease.

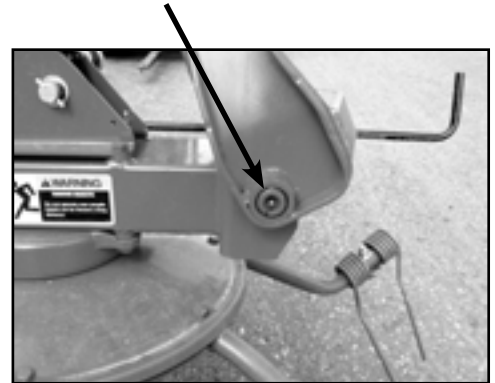

The tongue/main frame pivot is also greased through the pivot pin and should be kept wet with grease.



The tilt cylinder adjustment threads must be kept well greased to allow for easy adjustment for tine height.

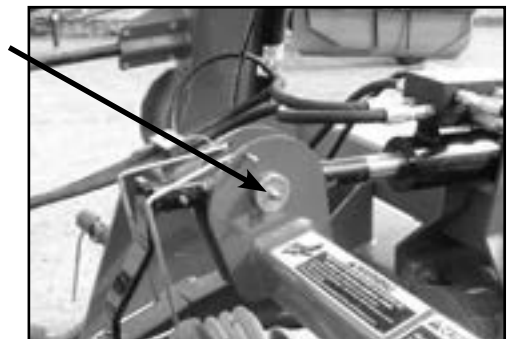

LUBRICATION & MAINTENANCE

PTO Shaft Lubrication

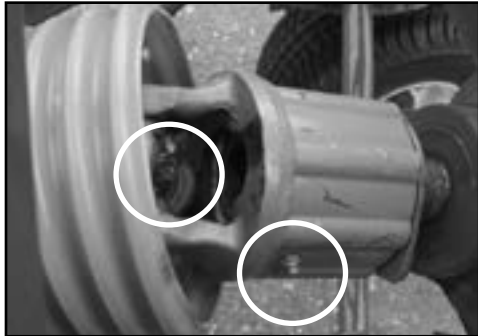

The radial pin clutch and the center cross in the pto yoke should be greased every 8 hours.



The front center cross should also be greased every 8 hours.



The pto guarding should be lubricated at all times. If the shield feels tight when it is extended and retracted then lubricate as necessary.

Timing the rotors

The rotor gears are set at the factory and should not need to be serviced or re-timed. However, when replacing a hexagonal drive shaft or gearbox it is necessary to time the rotors. The figures below show correctly timed rotors and incorrectly timed rotors.

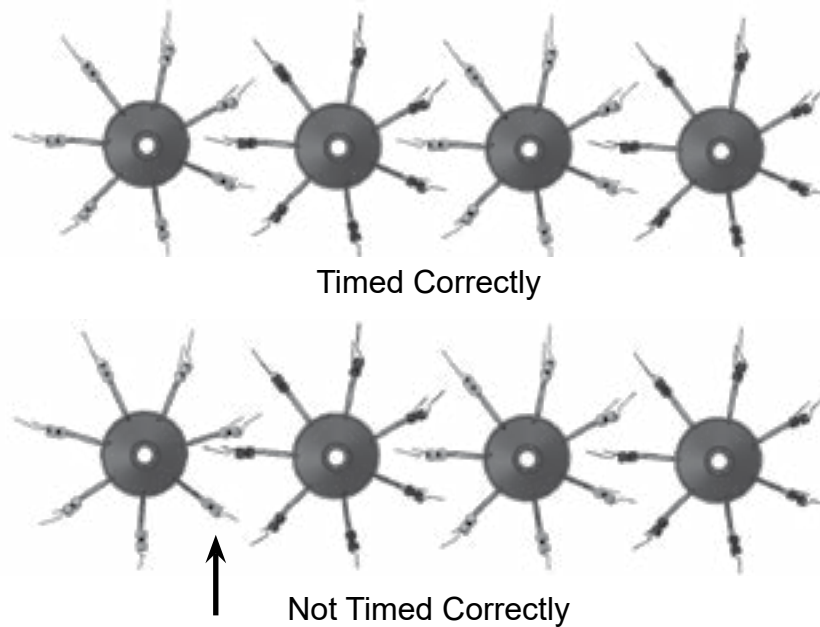

If something does happen that causes the gears to come out of time you can follow the steps below to re-time:

Tools Needed:

- Snap Ring Pliers
- Hammer
- Punch
- 9/16" Wrench or Impact

First, remove the outer guard cradles and guard from the side that has a incorrectly timed rotor. Then, fold the arms of the tedder up into transport mode. Remove the snap ring and bushing from the outside of the hex shaft.

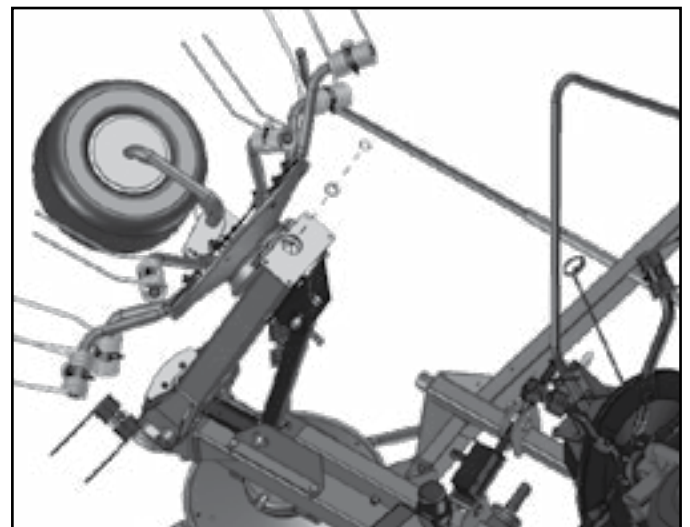
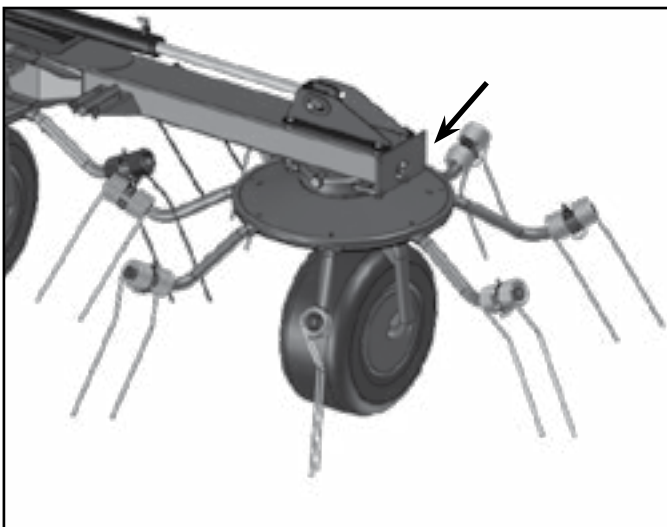

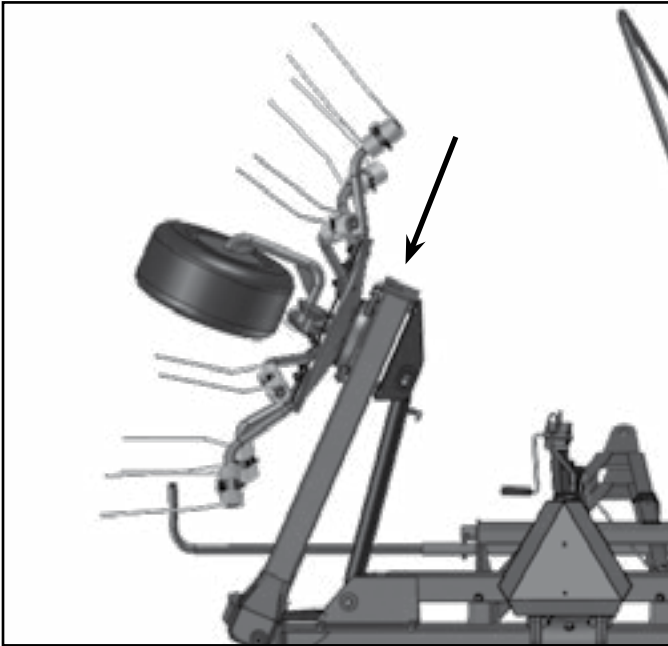

Next, use the hammer and punch to **slowly** work the hex shaft downward. The hex shaft only needs to be displaced 2.8" (clearing the input pinion of the rotary gearbox) in order to retime the rotor. Moving the hex shaft more than 3.3" will make the shaft more difficult to reinsert through the pinion. Turn the rotor back and forth continuously while working the hex shaft down. As soon as the outside rotor can move independently of the other 3 rotors, stop punching the hex shaft down.

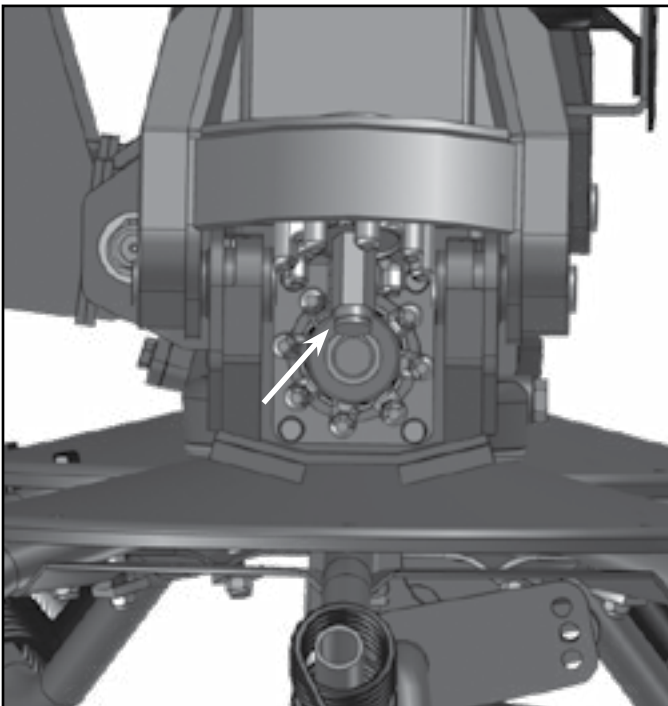

Rotate one of the three correctly timed rotors until the hex shaft sticking out is flat on the outside. This will be used as a reference so that the shaft can be reinserted back up with correct timing. The hex shaft shall remain in this position for the remainder of the re-timing process.

In order to properly time the outer rotor, the two conditions shown below must be met:

- 1) The spacing between the tines must be equal so that the tine from the outer wing rotor fits in the center of two tines from the center rotor.
- 2) The profile of the input pinion must be flat on the outside (matching the hex shaft profile determined in the previous step) so that the hex shaft will fit back through it.

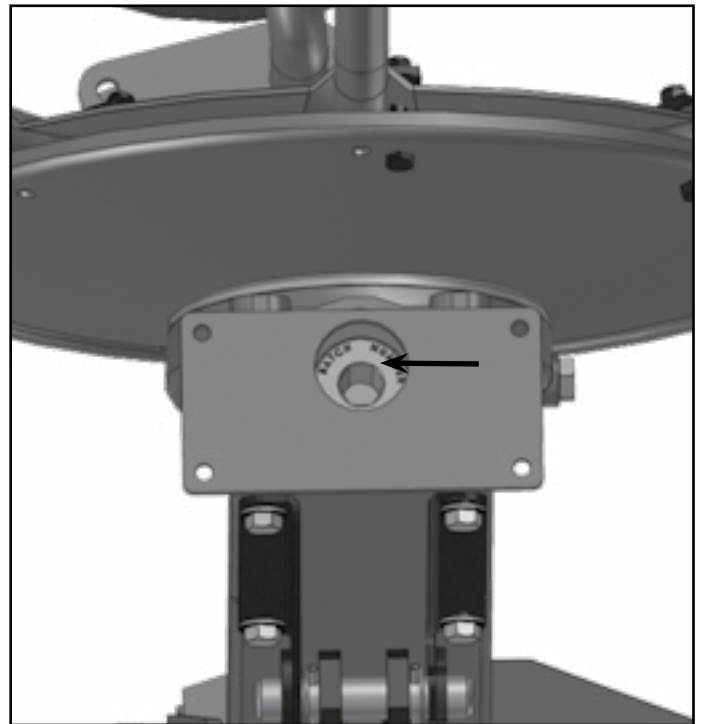
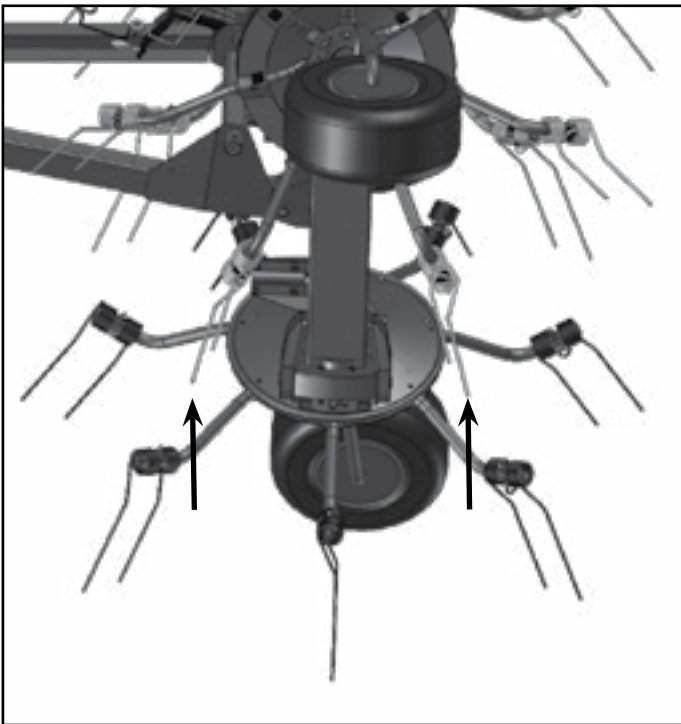

Turn the outer rotor until both conditions are met. When the rotor appears to be timed correctly, use a punch to push the hex shaft back to the original position. Do not force the hex shaft back through if it is tight. This may mean the profile of the hex shaft does not match the profile of the finger joint. After the hex shaft is through, put the bushing and snap ring back on the hex shaft and the guard cradle back in position.

Additional Notes: If multiple rotors are out of time, it is always best to start on the inside and work towards the outside. When one of the two center rotors are out of time, the hex shaft must be pushed through until it goes through the input pinion of the rotary gearbox. If this is the case, use a punch to slowly work the hex shaft down while turning one of the rotors back and forth. As soon as the rotors can move independently, do not push the hex shaft down any further. After that, the process is the same as in retiming the wing rotors.

Pequea Machine's Limited Warranty

Pequea Machine Company warrants to the original Purchaser all Machinery, Equipment, or Trailers manufactured by it, to be free from defects in material and workmanship under normal use and service. Its obligation under this Warranty shall be limited to replacement or repair of any parts thereof, free of charge to the original Purchaser, at its place of business, provided, however, that the part(s) to be replaced or repaired, shall within one (1) year after delivery to the original Purchaser, be demonstrated to be defective; which determination shall be made by the Company. The said components or parts must be returned through the Selling dealer or distributor directly to the Company with all transportation charges prepaid. Notice of defect shall be furnished in writing to the Seller and to the agent through whom the machinery was received, disclosing in full all known defects and failure in operation and use, and reasonable time shall be given to the Seller to remedy any such defects and failures. Failure to make such trial or give such notice shall be deemed an absolute acceptance by the Buyer and satisfaction in full of this Limited Warranty.

This Warranty does not cover, under any circumstances, any parts, components, or materials which, in the opinion of the Seller and Company, have been subjected to neglect, misuse, alteration, accident, or if repaired, with parts other than those manufactured by and obtained from Pequea Machine Company. This Warranty does not cover components which are already covered by a separate Warranty provided by the supplier of said parts or components. The Company's obligation under this Warranty is limited to repair or replacement, free of charge to the original Purchaser, of any part which in judgment of the Company is defective. This Warranty does not cover normal wear and tear.

THIS WARRANTY IS MADE EXPRESSLY IN LIEU OF ALL OTHER WARRANTIES, EXPRESSED OR IMPLIED, INCLUDING ANY WARRANTY OF MERCHANTABILITY AND FITNESS FOR USE AND PURPOSE AND OF ALL OTHER OBLIGATIONS OR LIABILITIES ON ITS PART AND ANY IMPLIED WARRANTY. AND IT NEITHER ASSUMES NOR AUTHORIZES ANY OTHER LIABILITY IN CONNECTION WITH A SALE OF THIS MACHINE. THIS WARRANTY SHALL NOT APPLY TO THIS MACHINE OR TO ANY PART THEREOF WHICH HAS BEEN SUBJECT TO ACCIDENT, NEGLIGENCE, ALTERATION, ABUSE, OR MISUSE.

The Company makes no Warranty whatsoever in respect to accessories or parts not supplied by the Company. The term "original Purchaser" as used in this warranty, shall be deemed that person for whom the Machine, Equipment, or Trailer is originally supplied. This Warranty shall apply only within the boundaries of the continental United States.

Under this Warranty, the Company cannot guarantee that existing conditions beyond its control will not affect its ability to obtain materials or manufacture necessary replacement parts.

No one is authorized to alter, modify, or change the terms of this Warranty in any manner.

The Company warrants the Construction of the equipment sold herein and will replace at its expense for a period of (1) year from the date hereof, any parts which prove defective as determined under the terms of this Limited Warranty.

Pequea Machine's Extended Gearbox Warranty

In addition to its Limited Warranty (outlined above), Pequea Machine Company warrants the gearbox assembly for all Turbo Tedder models (TT Series, excluding the following older models: TT4100, TT6100, TT6200, TT8100) for a total period of five (5) years from the date of purchase by the original purchaser as follows:

If the defect occurs within the first five (5) years, Pequea Machine will replace or repair the gearbox assembly. The obligation of the Company shall be limited to replacing or repairing the gearbox assembly, at the option of the Company. The Company shall not be responsible for any labor costs, or removal or reinstallation of the gearbox assembly, or any transportation costs to or from its facility in New Holland, PA. The defective gearbox assembly must be returned through the Selling dealer or distributor directly to the Company with all transportation charges prepaid. If the customer prefers, they can expedite delivery of a replacement gearbox assembly for a cost of \$150.00 plus freight charges (price subject to change at discretion of Company). The defective gearbox assembly must still be returned to the Company.



200 Jalyn Drive
P.O. Box 399
New Holland PA 17557

Phone: 717-354-4343
Fax: 717-354-8843
E-mail: pequea@pequeamachine.com
www.pequeamachine.com