



Vineyard & Orchard Spreader

Model GS-8, GS-10, GS-12

Operator's Manual



THIS MANUAL MUST BE READ AND UNDERSTOOD BEFORE ANYONE OPERATES THIS MACHINE!

Manual # 990041
Revised 08/15/2016

**YOU MUST FILL OUT YOUR WARRANTY REGISTRATION
TO ACTIVATE YOUR WARRANTY AND TO QUALIFY FOR
PARTS AND SERVICE!!**

To the Owner;

Thank-You for choosing a quality spreader from Pequea Machine, Inc. We strive to give you the best equipment and the best level of service of any company. With a little care and maintenance this machine will do your work for you for many years. In this manual, we make an effort to get you better acquainted with the spreader so you can achieve maximum performance. We design and build all of our equipment with the end user in mind so we welcome any suggestions or ideas for improvement.

Please take a few minutes to fill out the area below. This information will be valuable to you when ordering parts or requesting service from your dealer.

Dealer Name: _____

Dealer Phone Number: _____

Service Manager/Technician: _____

Model# and Description: _____

Serial Number: _____

Date of Purchase: _____

TABLE OF CONTENTS

Introduction	2
Serial Number	2
Specifications	2
Safety	3
General Safety Guidelines	3
Safety Decals and Reflectors	4
Hitching	5
Tractor Requirements	5
Attaching to the Tractor	5
Transport	6
Field Transport	6
Road Transport	6
Operation	7
Maintenance	8
General Maintenance	8
Wheel & Tire Maintenance	8
Wheel Bearing Maintenance	8
Grease Fitting Lubrication	8
Apron Chain Maintenance	9
Hydraulic System Maintenance	9
Options and Attachments	10
Spinner Attachment	10
Side Deflector Option	10
Warranty	11
Notes	12

INTRODUCTION

Thank-You for choosing a Pequea Spreader. Your spreader is the result of years of research and development work. This Operator’s Manual will familiarize the operator with the safety and operation of the machine. Included are complete instructions for safe and efficient operation, lubrication, and maintenance procedures. Understanding and following these procedures will result in years of maximum performance from your Pequea Spreader.

Read entire manual before operating. Failure to follow the instructions outlined in this manual may result in personal injury and/or damaged equipment, and could void the warranty.

Serial Number

The serial number consists of five numerical digits and can be found on a small yellow sticker on the left front corner of the spreader box (Figure 1). Please use this number when requesting service, seeking information, or ordering parts. For the operator’s convenience, space to record the serial number, model number, purchase date, and dealer has been provided inside the front cover of this manual.



Figure 1









All pictures and instructions in this manual assume that the right and left side of the machine are that of someone standing behind the machine facing forward.

Specifications

Standard Features	G8	G10	G12
Hopper Length	8'	10'	12'
Hopper width (at top of Gable)	60"		
Overall Height	67 - 73"		
Overall Length (without attachment)	194"	218"	242"
Wheel Base (center to center)	57.5"		
Tires	21.5L x 16.1 x 10-Ply on 8 Bolt Wheel		
Material Cap. (Heaped)	4.3 Cu. Yd.	5.4 Cu. Yd.	6.5 Cu. Yd.
Payload	13,000 lbs	13,000 lbs	13,000 lbs
Empty Weight	2,930 lbs	3,150 lbs	3,370 lbs
Floor	3/4 x 6 Tongue & Groove Poly		
Floor Chain	88K, 32" Wide Web		
Removable Spinner Attachment	Optional	Optional	Optional
Spinner Disc Thickness	1/4" plate		
Spinner Diameter	25"		
Spinner Paddles	(6) Bolt On Reinforced		
Electronic Floor Shut-Off	Standard		
Oil Cooler	Optional		
Dual Rear Conveyer	Optional		

SAFETY

General Safety Guidelines

-  ***This symbol precedes specific safety instructions throughout this manual. When reading the manual pay close attention to the information that follows this symbol***
-  FAILURE TO FOLLOW INSTRUCTIONS IN THIS MANUAL COULD RESULT IN PERSONAL INJURY OR DEATH. READ ENTIRE MANUAL BEFORE OPERATING THE MACHINE!
-  Keep hands, feet, and clothing away from all moving parts.
-  Never allow riders on the spreader or the tractor.
-  Make sure that all persons are a safe distance away before moving the spreader or engaging the spinners or conveyer.
-  When transporting the machine on public roads use the proper reflectors, lights, and slow moving vehicle signs required by local government agencies.
-  Stop the tractor engine, remove ignition key, and allow all mechanisms to stop before cleaning, adjusting, or lubricating the machine. Never attempt to pull material from any part of the machine while it is running
-  Do not attempt to operate the spreader in areas with steep inclines, ditches, large rocks, stumps or holes which may endanger the operator by upsetting the tractor and/or the spreader.
-  Avoid contact with hydraulic lines, they may be under extreme pressure or heat. Never go near a hydraulic leak until the pressure has been relieved and the leaking has stopped. A high pressure hydraulic leak can easily penetrate your skin and cause serious injury, gangrene or death.

We at Pequea Machine, Inc. try to provide safety shield and guards wherever possible, however, it is impossible to shield every area that could be dangerous. We will not be responsible for carelessness and misuse of any of our equipment.

SAFETY

Safety Decals and Reflectors

Decals and reflectors are for the protection of yourself and others. If they are missing, faded, or not readable, get replacements from your dealer immediately. Shown below are some of the warning decals used on your spreader.



HITCHING

Tractor Requirements

Your spreader is equipped with a 540 RPM PTO hydraulic pump and must be matched with a tractor that meets this requirement.

Attaching to the tractor

Line up the hole in the tractor draw bar with the hitch on the spreader and insert an approved hitch pin with a locking device or safety clip. The spreader hitch (Figure 2) is attached with four bolts and can be moved up or down to accommodate various draw bar heights.

Attach the safety chain(s) to the tractor draw bar.

Raise the jack drop leg and secure with drop leg pin.

Attach the hydraulic pump (Figure 3) to the tractor PTO output shaft and secure it to the tractor by using a chain around the stabilizer bar. The chain will both keep the pump from rotating and will keep it from sliding off the shaft.

Plug in the wiring for the lights (if lighting option has been installed) and make sure that the lights and turn signals are working properly.

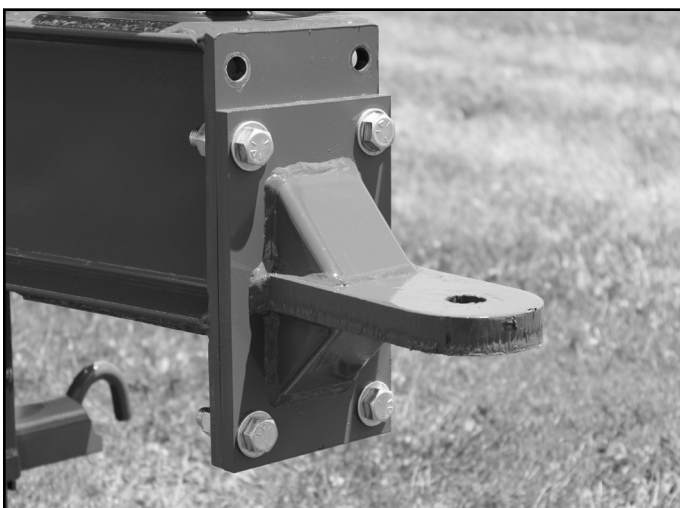

Figure 2



Figure 3

TRANSPORT

Field Transport

Never allow passengers on the spreader or the tractor.

Avoid tight turns to reduce the risk of loss of control.

Remain fully aware of the width and length of the spreader in relation to the objects you are passing, either stationary or moving.

Never travel at speeds over 10 MPH in the field when loaded.

For level or rolling terrain, tractor weight must be at least 50% of gross loaded spreader weight. For hilly terrain, road travel, or other adverse conditions, tractor weight must be equal to, or more than the gross loaded spreader weight.

Road Transport

Adhere to all suggestions for transport in the field listed above.

Follow all local regulations for moving agricultural equipment on public roads, especially those related to reflectors, SMV (slow moving vehicle) symbols and safety markers.

Be sure to use flashing lights at all times when transporting on public roads.

Slow down when turning to avoid instability and loss of control

Never travel at speeds over 20 MPH on the road.

OPERATION

General Operation

The apron and attachment functions on the spreader are driven hydraulically by the hydraulic pump run by the tractor PTO.

The spreader is equipped with a hydraulic manifold with precision hydraulic valves (Figure 4) to fine-tune both the attachment and apron chain speed to accommodate a wide range of spread patterns, material density and much more. To change the settings, raise the glass cover and rotate the knobs to the desired position.

The metering gate in the rear can be adjusted manually from 0-13" to control the depth of material flowing out onto the attachment. It is adjusted by turning the end gate wheel (Figure 5) to the desired position and engaging the spring loaded lock pin. Turn the wheel clockwise to raise the gate and counter-clockwise to lower it.



Figure 4

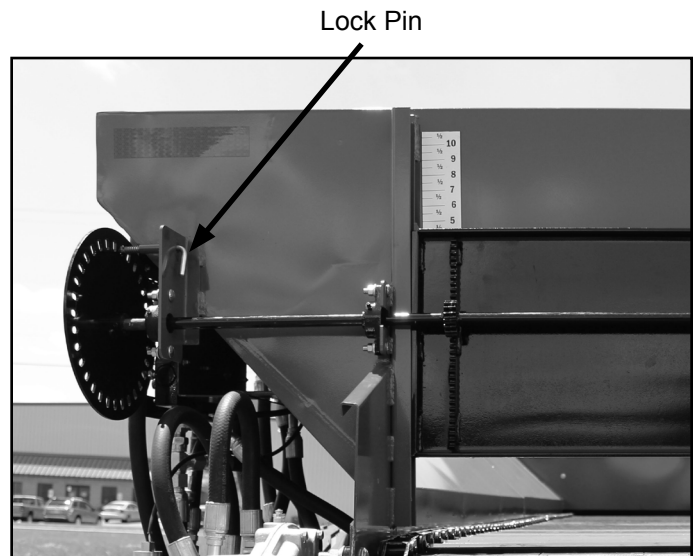

Figure 5

The remote floor shut off switch (Figure 6) is used to temporarily stop the apron chain while the spinners are still rotating. This feature is used when the operator makes a turn or passes through an area where no material is to be spread.



Figure 6

The axle can be adjusted by removing the bolts that hold the axle hanger in place. Before adjusting the axle, make sure the spreader is safely supported on both sides. Keep in mind the weight of the spreader. **Always keep at least 6 bolts in to secure the axle hanger in place.**

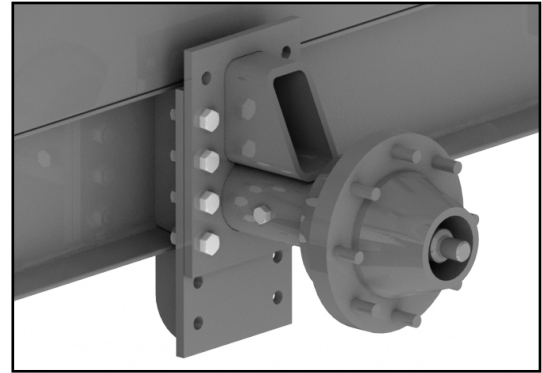

Figure 7

MAINTENANCE

General Maintenance

Check the spreader each time it is used for loose, bent, broken or missing parts or fasteners.

Never store material in the spreader in cold weather. The material could freeze against the sides and floor of the spreader and cause severe damage to the apron drive system.

Clean the excess manure off the sides of the spreader after each use. Manure is highly acidic so if there are any scratches in the paint it will immediately begin to rust.

Wheel & Tire Maintenance

Check wheel lug torque once a month or after each period of use. Wheel lugs should be torqued to 120 ft./lbs.

Check tire pressure before each period of use. Recommended tire pressure is stamped on the sidewall of each tire.

Wheel Bearing Maintenance

Remove the hub and check consistency of the wheel bearing grease at least once a year. If the grease is not the same consistency of fresh grease (either dry and caked or too thin) repack the bearings with fresh grease. Retighten the spindle nut to 25 ft. lb., then back off one notch to insert cotter pin.

MAINTENANCE

Grease Fitting Lubrication

The spreader is designed to require minimal lubrication. However, the importance of sufficient and proper lubrication cannot be over emphasized as it is the best insurance against unnecessary repairs and will greatly increase the life and performance of the machine.

Lubricate all the grease fitting every six months or after 50 loads, whichever comes first. Be careful not to over grease the sealed bearings as too much grease could push out the seal and allow dust or debris to contaminate the bearing. One half of a stroke from a manual grease pump should be sufficient. Be sure to wipe all the dust and debris away from the grease fitting before greasing. If it is not clean you may force some dirt into the bearing.

Non sealed (friction) grease points will not be damaged by over greasing and should be kept visibly wet with grease. **NOTE:** There are friction grease points on the axle pivots. These are especially critical to be kept well greased at all times.

Apron Chain Maintenance

Apply chain lube to the apron chain after each period of use to lubricate and prohibit rust.

The apron chain may need to be tightened periodically. 75 to 90 percent of the lower chain strand should be lying on the chain guides. The apron chain can be adjusted by using the apron tensioner bolts (Figure 7) on the front of the spreader. Be sure to adjust both sides equally so the chain is pulling straight.

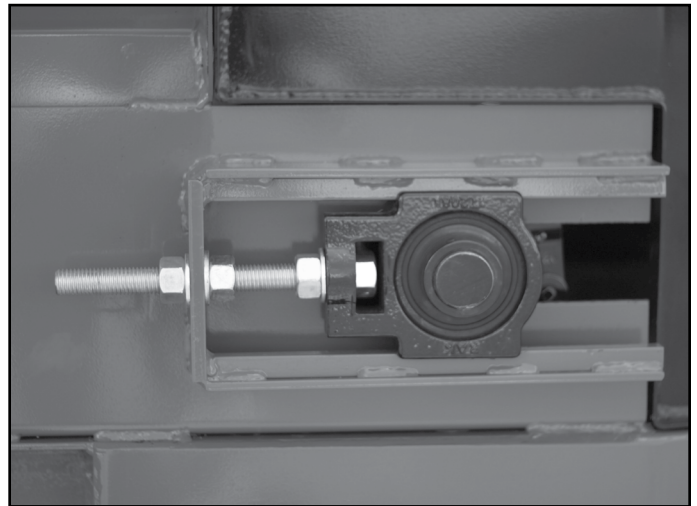

Figure 7

MAINTENANCE

Hydraulic System Maintenance

The hydraulic system is virtually maintenance free since it is a fully self contained system. However, you may need to add oil to the reservoir to keep it at the proper level. See Figure 7 below for recommended oil level. Recommended oil type is universal tractor fluid (UTF). Required amount is approximately 40 gal.

Recommended
Oil Level

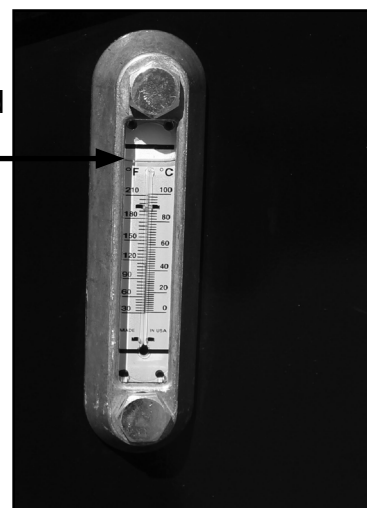

Figure 7

Gearbox Maintenance

The double motor drive gearbox (Figure 9) should be serviced once a year. Drain the oil and then fill up to the check plug with new #90 gear oil. Required amount is approximately 24 oz.

The oil filter on the main reservoir should be changed periodically. Use only a 10 micron filter designed for hydraulic oil.

Check Plug



Figure 9

OPTIONS AND ATTACHMENTS

Spinner Attachment

The spinner attachment is used to distribute material evenly over a wide area behind and on both sides of the spreader. Spread widths of up to 25' can be achieved when the spinners are operating at full speed.

The spinner attachment can be moved forward or back to increase or decrease the spread width.

Side Deflector Option

The side deflector option is to be used in conjunction with the spinner attachment and directs all the material out on both sides and none directly behind the spreader. This is typically used to top dress fertilizers and other materials in orchards.

Side Conveyor Attachment

The side conveyor option is to be used as a double row mulcher. The speed of the conveyor belts determines the distance the material is thrown out beyond the end of the conveyers.

The spreader can also be used without an attachment if the material is to be transported onto a pile. To remove the attachment, disconnect the three hydraulic couplers. The two larger ones can be coupled together to avoid contaminating the oil. Next, remove the two lock pins from the attachment mount then slide the attachment straight back until it is free.

Oil Cooler Option

The Grape Spreader is equipped with a large capacity oil reservoir that is sufficient to keep the oil cool in most climates. However, if the spreader is being used in an extremely warm, sunny climate the oil cooler option will help keep the oil temperature at a safe level.



Spinner attachment (With deflector option)

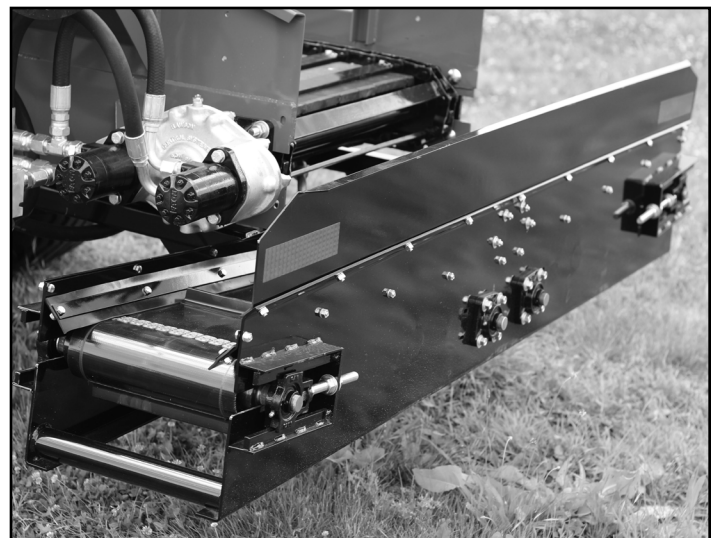

Side conveyor attachment

WARRANTY

Pequea Machine's Limited Warranty

Pequea Machine Company warrants to the original Purchaser all Machinery, Equipment, or Trailers manufactured by it, to be free from defects in material and workmanship under normal use and service. Its obligation under this Warranty shall be limited to replacement or repair of any parts thereof, free of charge to the original Purchaser, at its place of business, provided, however, that the part(s) to be replaced or repaired, shall within one (1) year after delivery to the original Purchaser, be demonstrated to be defective; which determination shall be made by the Company. The said components or parts must be returned through the Selling dealer or distributor directly to the Company with all transportation charges prepaid. Notice of defect shall be furnished in writing to the Seller and to the agent through whom the machinery was received, disclosing in full all known defects and failure in operation and use, and reasonable time shall be given to the Seller to remedy any such defects and failures. Failure to make such trial or give such notice shall be deemed an absolute acceptance by the Buyer and satisfaction in full of this Limited Warranty.

This Warranty does not cover, under any circumstances, any parts, components, or materials which, in the opinion of the Seller and Company, have been subjected to neglect, misuse, alteration, accident, or if repaired, with parts other than those manufactured by and obtained from Pequea Machine Company.

This Warranty does not cover components which are already covered by a separate Warranty provided by the supplier of said parts or components.

The Company's obligation under this Warranty is limited to repair or replacement, free of charge to the original Purchaser, of any part which in judgment of the Company is defective. This Warranty does not cover normal wear and tear.

THIS WARRANTY IS MADE EXPRESSLY IN LIEU OF ALL OTHER WARRANTIES, EXPRESSED OR IMPLIED, INCLUDING ANY WARRANTY OF MERCHANTABILITY AND FITNESS FOR USE AND PURPOSE AND OF ALL OTHER OBLIGATIONS OR LIABILITIES ON ITS PART AND ANY IMPLIED WARRANTY. AND IT NEITHER ASSUMES NOR AUTHORIZES ANY OTHER LIABILITY IN CONNECTION WITH A SALE OF THIS MACHINE. THIS WARRANTY SHALL NOT APPLY TO THIS MACHINE OR TO ANY PART THEREOF WHICH HAS BEEN SUBJECT TO ACCIDENT, NEGLIGENCE, ALTERATION, ABUSE, OR MISUSE.

The Company makes no Warranty whatsoever in respect to accessories or parts not supplied by the Company. The term "original Purchaser" as used in this warranty, shall be deemed that person for whom the Machine, Equipment, or Trailer is originally supplied. This Warranty shall apply only within the boundaries of the continental United States.

Under this Warranty, the Company cannot guarantee that existing conditions beyond its control will not affect its ability to obtain materials or manufacture necessary replacement parts.

No one is authorized to alter, modify, or change the terms of this Warranty in any manner.

The Company warrants the Construction of the equipment sold herein and will replace at its expense for a period of (1) year from the date hereof, any parts which prove defective as determined under the terms of this Limited Warranty.

NOTES



200 Jalyn Drive
P.O. Box 399
New Holland PA 17557

Phone: 717-354-4343
Fax: 717-354-8843
E-mail: pequea@pequeamachine.com
www.pequeamachine.com